

## EXR1



### EXR1

ITALIANO

<b>TIPOLOGIA</b>	CATENA ENDURO/OFFROAD
<b>NOME</b>	<b>EXR1</b>
<b>DESCRIZIONE</b>	Catena Sunstar 520EXR1 (EXR1 = Enduro/Cross Racing )
<b>CODICE</b>	SS520EXR1-XXXG
<b>CARATTERISTICHE TECNICHE E BENEFICI</b>	La catena Sunstar 520EXR1 (EXR1 = Enduro/Cross Racing ) è una catena che presenta un nuovo o-ring stile Dual-Guard ma con una forma molto affusolata che risulta essere più sottile del nostro classico o-ring a doppia tenuta. Questo nuovo design dell'o-ring aiuta a ridurre il peso complessivo tenendo comunque altissime le prestazioni. Questa è la scelta ideale per i piloti fuoristrada che preferiscono una catena a lunga durata senza rinunciare al peso ridotto. La 520EXR1 è disponibile in passo 520, ha un peso di circa 3,8 lbs/1,71kg per 120 link e con carico di rottura massimo di 8.390lbs /33.700N. Disponibile in colore oro (piastrine esterne oro/ interne neutre) utilizza una falsa maglia da ribadire molto resistente.
<b>O-RING</b>	DUAL GUARD
<b>ACCESSORI</b>	Pignoni P-DRIVE, corone STEEL, TRIPLE STAR, WORKS Z
<b>CONFRONTO</b>	

Modello catena	N. Link disponibili	Tipo oring	Falsa maglia	Max CC Street / Offroad	PESO 100LINK (LBS)	PESO 100LINK (KG)	Lunghezza pin (mm)	Spessore piastra interna	Spessore piastra esterna	Tensione massima (lbs)	Tensione massima (N)
420MXR	104 - 140	None	Clip	150 / 150	1.76	0.79	15,70	1.80	1.45	4,980	22,152
428MXR	118 - 142	None	Clip	50 / 150	2.13	0.97	17,60	1.80	1.80	5,780	25,710
520MXR1	108 - 120	None	Clip	NA / 500	2.99	1.36	17,70	1.80	2.00	8,970	39,900
<b>520EXR1</b>	<b>108 - 120</b>	<b>Dual Guard</b>	<b>Rivet</b>	<b>NA / 450</b>	<b>3.23</b>	<b>1.46</b>	<b>18,35</b>	<b>2.00</b>	<b>2.00</b>	<b>8.390</b>	<b>37,300</b>
520SSR	100 - 120	O-ring	Clip	400 / 400	3.36	1.52	19,90	2.00	2.00	7,670	34,117
520RDG	106 - 120	DualGuard	Rivet	750 / 750	3.39	1,54	19,90	2.00	2.00	8,490	37,765
525RDG	100 - 124	DualGuard	Rivet	900 / 750	4.30	1.95	22,85	2.40	2.30	8,820	39,233
530RDG	102 - 122	DualGuard	Rivet	1000 / 750	4.47	2.03	24,90	2.40	2.30	9,480	42,169
520XTG	104 - 120	TripleGuard	Clip	400 / 750	3.75	1.70	20,80	2.00	2.00	8,460	37,631
520RTG1	98 - 120	TripleGuard	Rivet	1000 / 750	3.75	1.70	20,80	2.20	2.20	8,800	39,144
525RTG1	100 - 124	TripleGuard	Rivet	1000 / 750	4.30	1.95	22,85	2.40	2.30	9,300	41,368
530RTG1	106 - 120	TripleGuard	Rivet	1400 / 900	4.63	2.10	24,90	2.40	2.40	9,900	44,037

### CARATTERISTICHE DELLE CATENE SUNSTAR

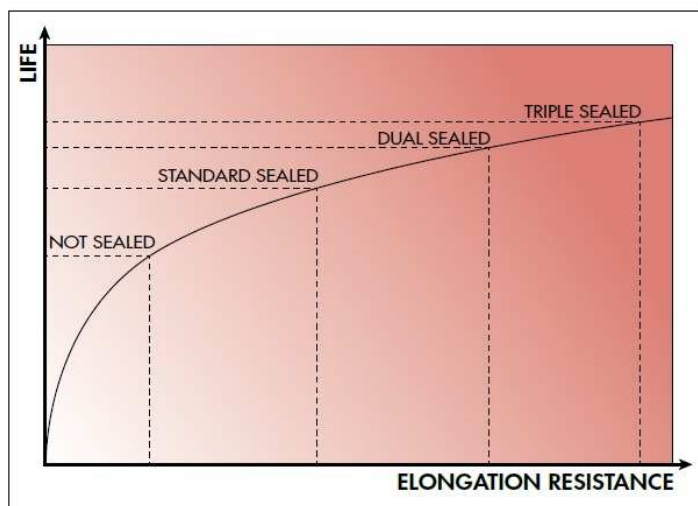

### DIFFERENTI TIPOLOGIE DELLE GUARNIZIONI SUNSTAR

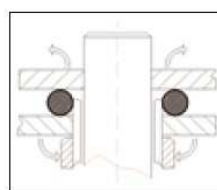

Standard sealed chain SSR

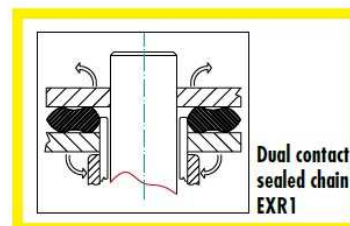

Dual contact sealed chain EXR1

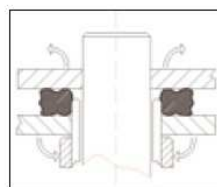

Dual contact sealed chain RDG

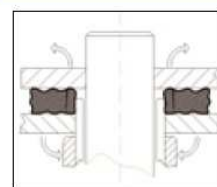

Triple contact sealed chain XTG - RTG1

# EXR1

Link	Listino Catene											
	420MXR	428MXR	520MXR1	520EXR1	520SSR	520RDG	525RDG	530RDG	520XTG	520RTG1	525RTG1	530RTG1
98										125,20		
100					71,80		96,10				147,20	
102					73,10			104,30		130,20		
104	32,00				74,50				102,80			
106					75,80	86,90	101,70	108,20	104,70	135,10		175,70
108			74,70	101,40	77,20		103,50	110,20	106,60		158,80	179,00
110	33,70		76,00	103,20	78,50	90,10	105,40	112,20	108,50	140,10	161,70	182,20
112	34,20		77,40	105,00	79,90	91,70	107,20	114,10	110,40	142,50	164,60	185,50
114			78,70	106,80	81,20	93,20	109,10	116,10	112,30	145,00	167,40	188,70
116	35,30		80,00	108,60	82,60	94,80	110,90	118,10	114,20	147,50	170,30	192,00
118	35,90	47,40	81,30	110,40	83,90	96,40	112,80	120,10	116,10	150,00	173,20	195,30
120	36,40	48,10	82,70	112,30	85,30	98,00	114,60	122,00	118,00	152,40	176,10	198,50
122		48,80						124,00				201,80
124	37,50	49,60					118,30				181,90	
126	38,10	50,30										
128		51,00										
130	39,20	51,80										
132		52,50										
134		53,20										
136		54,00										
140	41,90	55,40										
142		56,20										
1 mt.	23,50	31,00	41,00	57,10	44,10	51,20	59,10	62,70	60,10	79,70	91,10	103,70
Clip link	2,00	2,40	3,30	5,40	4,50	5,10	5,10	5,30	5,40	7,30	5,60	5,80



# EXR1

<b>TYPE</b>	OFFROAD/ENDURO CHAIN
<b>SERIES</b>	<b>EXR1</b>
<b>DESCRIPTION</b>	Sunstar's 520EXR1 Works EnduroCross Racing DualGuard chain
<b>PART NUMBER</b>	SS520EXR1-XXXG
<b>TECHNICAL FEATURES AND BENEFITS</b>	Sunstar's 520EXR1 Works EnduroCross Racing DualGuard chain features a new DualGuard sealed ring style that is thinner than our standard DualGuard seal which helps reduce overall weight without sacrificing performance. This is a great choice for off road riders who prefer the life of a sealed ring chain but are looking for something lighter in weight. The 520EXR1 available in 520 pitch and weighs approximately 3.8 lbs for the 120L length & is very strong with a tensile strength rating of 8,390 lbs. It's versatile usage includes cross country, enduro & motocross. The 520EXR1 uses a press fit, clip type connecting link in the gold colour option (gold outer plates/natural inner).
<b>O-RING</b>	DUAL GUARD
<b>ACCESSORIES</b>	P-DRIVE front sprocket, STEEL, TRIPLESTAR, WORKS Z SPROCKETS
<b>COMPARE</b>	

ENGLISH

Chain Model	Length Options	Ring Type	Link Type	Max CC Street / Offroad	Weight 100L (LBS)	Weight 100L (KG)	Pin Length (mm)	Inner Plate Thick-ness	Outer Plate Thick-ness	Maximum Tensile Strength (lbs)	Maximum tensile strength (N)
420MXR	104 - 140	None	Clip	150 / 150	1.76	0.79	15,70	1.80	1.45	4,980	22,152
428MXR	118 - 142	None	Clip	50 / 150	2.13	0.97	17,60	1.80	1.80	5,780	25,710
520MXR1	108 - 120	None	Clip	NA / 500	2.99	1.36	17,70	1.80	2.00	8,970	39,900
<b>520EXR1</b>	<b>108 - 120</b>	<b>Dual Guard</b>	<b>Rivet</b>	<b>NA / 450</b>	<b>3.23</b>	<b>1.46</b>	<b>18,35</b>	<b>2.00</b>	<b>2.00</b>	<b>8.390</b>	<b>37,300</b>
520SSR	100 - 120	O-ring	Clip	400 / 400	3.36	1.52	19,90	2.00	2.00	7,670	34,117
520RDG	106 - 120	DualGuard	Rivet	750 / 750	3.39	1,54	19,90	2.00	2.00	8,490	37,765
525RDG	100 - 124	DualGuard	Rivet	900 / 750	4.30	1.95	22,85	2.40	2.30	8,820	39,233
530RDG	102 - 122	DualGuard	Rivet	1000 / 750	4.47	2.03	24,90	2.40	2.30	9,480	42,169
520XTG	104 - 120	TripleGuard	Clip	400 / 750	3.75	1.70	20,80	2.00	2.00	8,460	37,631
520RTG1	98 - 120	TripleGuard	Rivet	1000 / 750	3.75	1.70	20,80	2.20	2.20	8,800	39,144
525RTG1	100 - 124	TripleGuard	Rivet	1000 / 750	4.30	1.95	22,85	2.40	2.30	9,300	41,368
530RTG1	106 - 120	TripleGuard	Rivet	1400 / 900	4.63	2.10	24,90	2.40	2.40	9,900	44,037

## DISTINCTIVE FEATURES OF SUNSTAR CHAIN

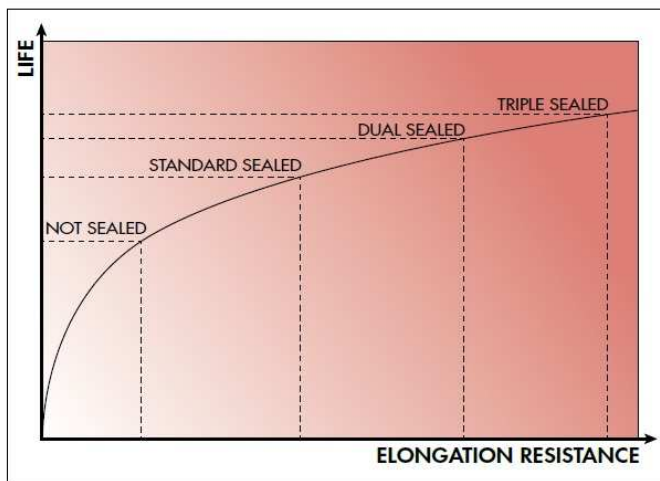

## DIFFERENT TYPES OF OUR SUNSTAR-SEAL LINE UP

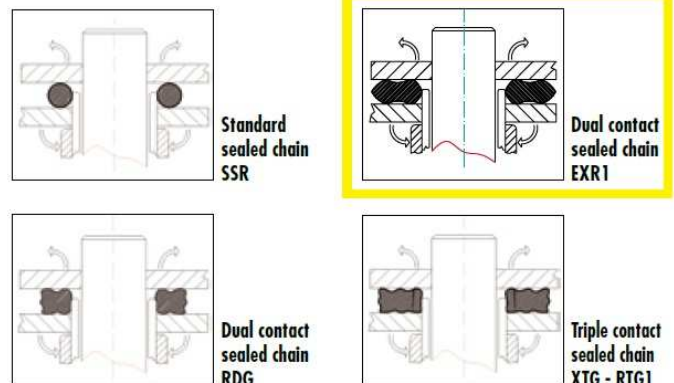

# EXR1

Link	Chains price list											
	420MXR	428MXR	520MXR1	520EXR1	520SSR	520RDG	525RDG	530RDG	520XTG	520RTG1	525RTG1	530RTG1
98										125,20		
100					71,80		96,10				147,20	
102					73,10			104,30		130,20		
104	32,00				74,50				102,80			
106					75,80	86,90	101,70	108,20	104,70	135,10		175,70
108			74,70	101,40	77,20		103,50	110,20	106,60		158,80	179,00
110	33,70		76,00	103,20	78,50	90,10	105,40	112,20	108,50	140,10	161,70	182,20
112	34,20		77,40	105,00	79,90	91,70	107,20	114,10	110,40	142,50	164,60	185,50
114			78,70	106,80	81,20	93,20	109,10	116,10	112,30	145,00	167,40	188,70
116	35,30		80,00	108,60	82,60	94,80	110,90	118,10	114,20	147,50	170,30	192,00
118	35,90	47,40	81,30	110,40	83,90	96,40	112,80	120,10	116,10	150,00	173,20	195,30
120	36,40	48,10	82,70	112,30	85,30	98,00	114,60	122,00	118,00	152,40	176,10	198,50
122		48,80						124,00				201,80
124	37,50	49,60					118,30				181,90	
126	38,10	50,30										
128		51,00										
130	39,20	51,80										
132		52,50										
134		53,20										
136		54,00										
140	41,90	55,40										
142		56,20										
1 mt.	23,50	31,00	41,00	57,10	44,10	51,20	59,10	62,70	60,10	79,70	91,10	103,70
Clip link	2,00	2,40	3,30	5,40	4,50	5,10	5,10	5,30	5,40	7,30	5,60	5,80